

# MULTI WAY AUDIO AND VIDEO DOOR ENTRY KITS

## 8 WAY VIDEO DOOR ENTRY KIT



## INSTALLATION GUIDE

**bticino**

A brand of **legrand**

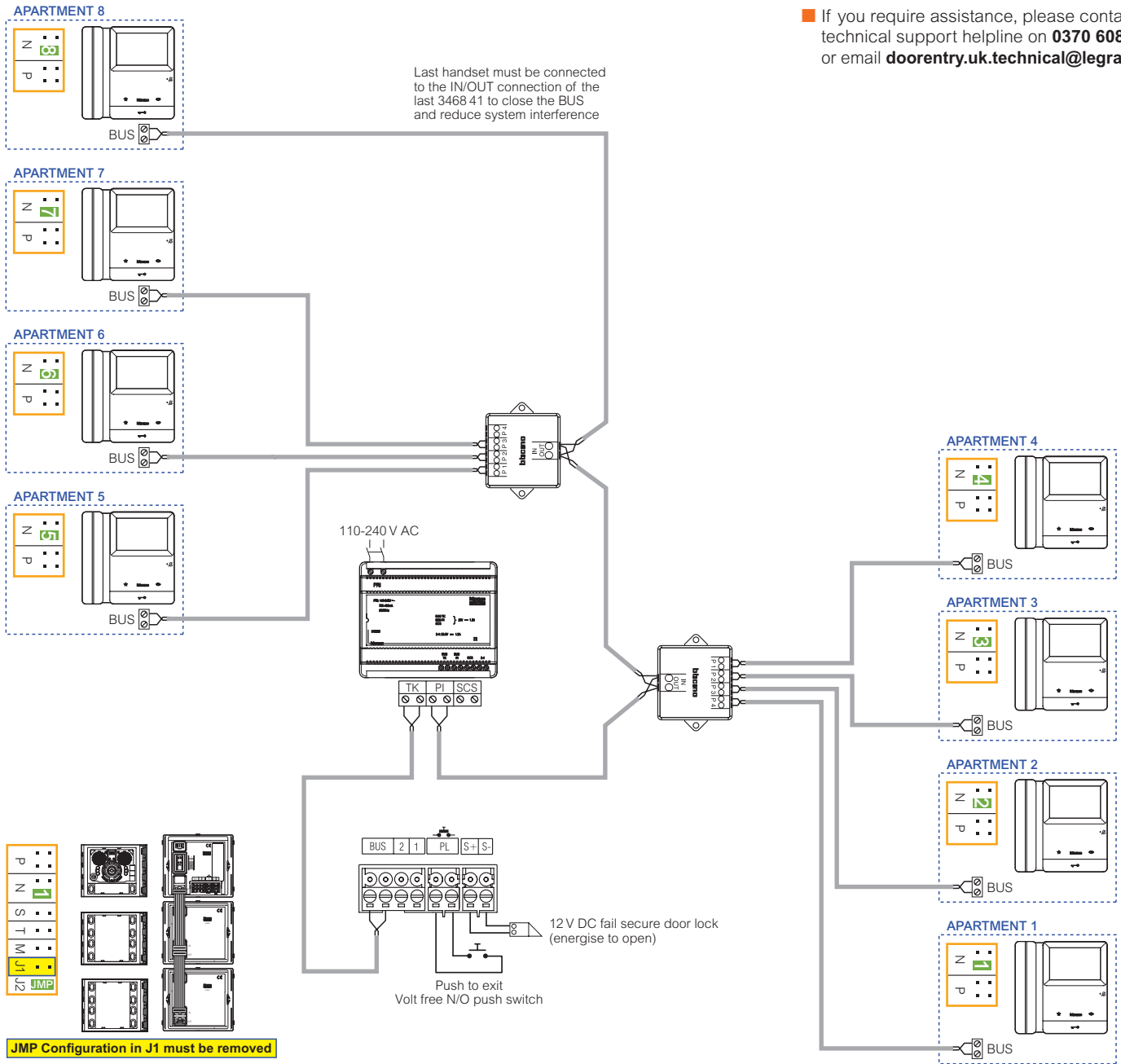

■ If you require assistance, please contact our technical support helpline on **0370 608 9020** or email **doentry.uk.technical@legrand.com**

- We recommend Bticino cable Cat. No. **3369 04**, see guidance notes for usage of different cable types  
 BUS cable connections are non polarised meaning the cable cores can be terminated in either connection terminal

**ALL CONFIGURATION SHOULD BE DONE WHILE THE SYSTEM IS POWERED OFF!**

**ENTRANCE PANEL CONFIGURATION**

Mic/Speaker adjustment  
Use orange adjustment tool  
provided with A/V module

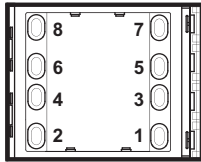
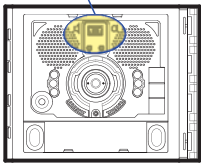

Push button layout

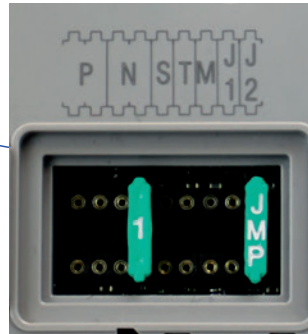
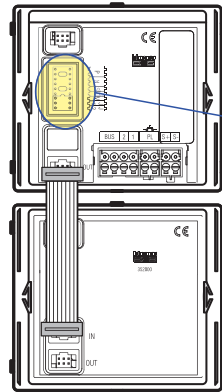

Ensure configuration matches the image for this system

**EXAMPLE HANDSET CONFIGURATION**

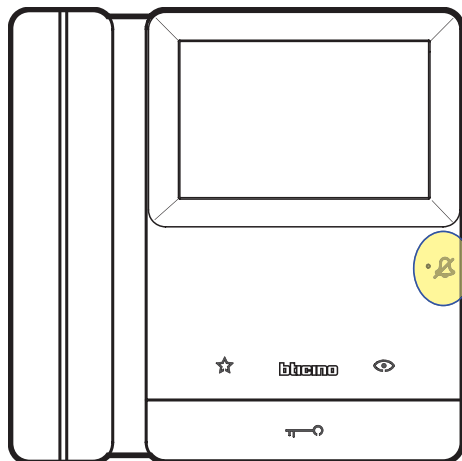

Internal unit  
Ringer volume/  
Call exclusion

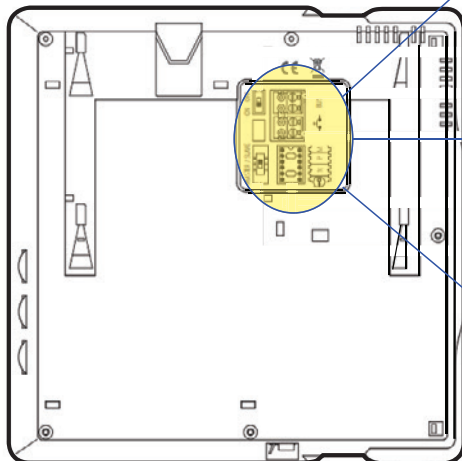

Switch = Always Set to Master

End of line Always ON

**Apartment 1 Configuration 1**

1	
N	P

Switch = Always Set to Master

End of line Always ON

**Apartment 8 Configuration 8**

8	
N	P

Switch = Always Set to Master

End of line Always ON

**Apartment 14 Configuration 14**

14	
N	P

■ If you require assistance, please contact our technical support helpline on **0370 608 9020** or email [doentry.uk.technical@legrand.com](mailto:doentry.uk.technical@legrand.com)

## DOOR LOCK WIRING EXAMPLES

### EXAMPLE 1 - Fail secure door dock (energise to open)

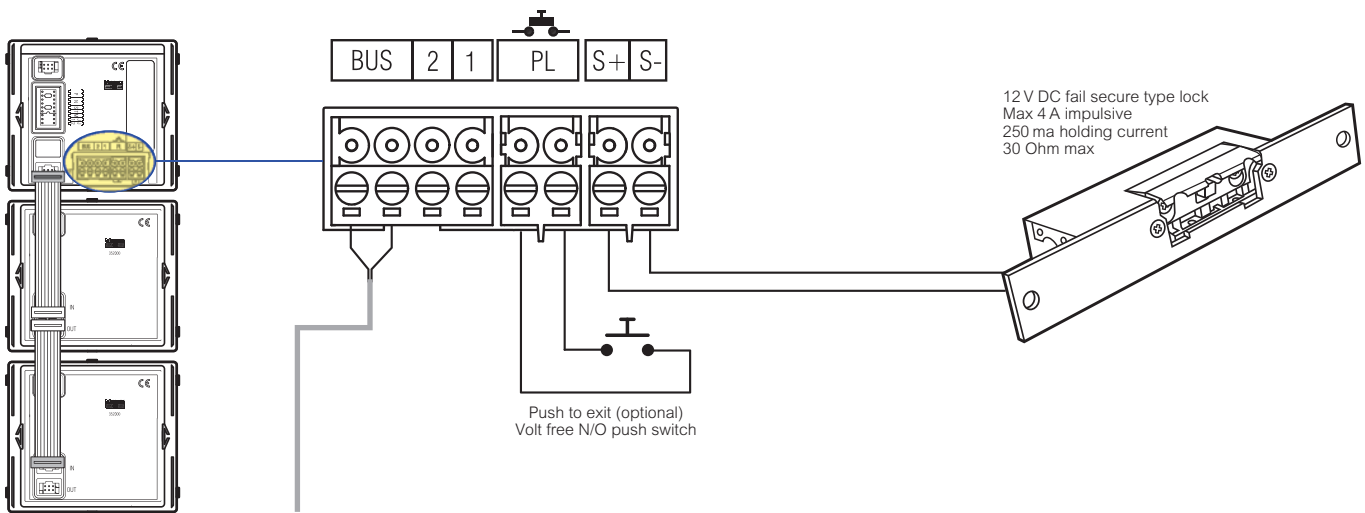

### EXAMPLE 2 - Fail safe door dock (de-energise to open)

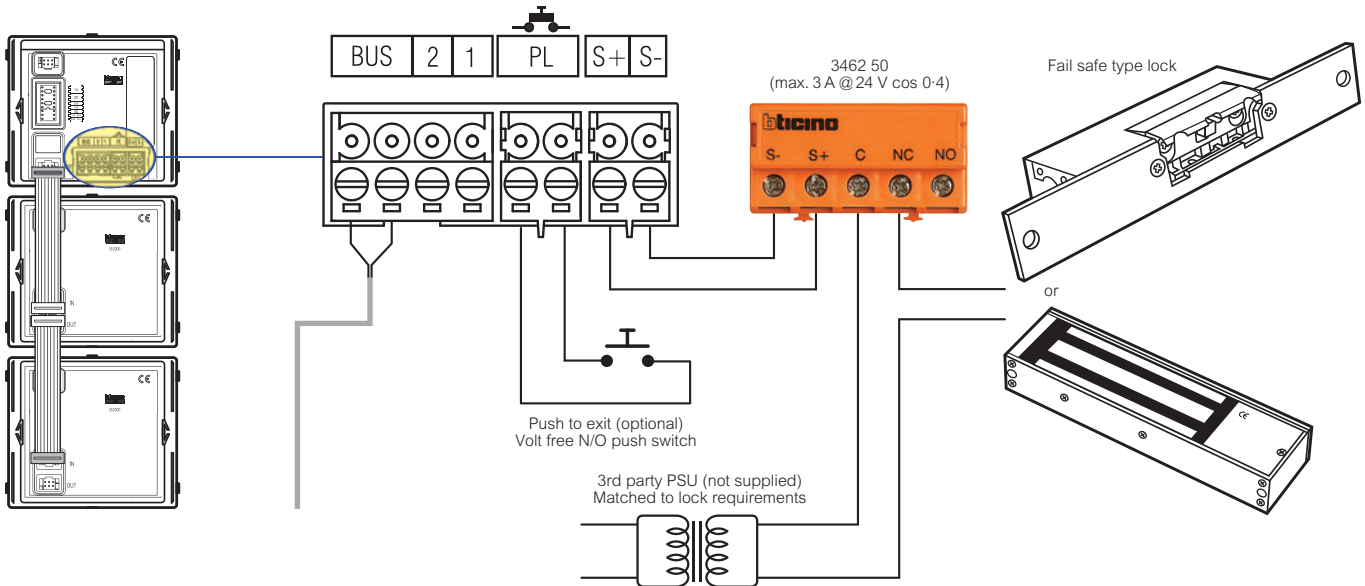

### EXAMPLE 3 - Motorised gates / volt free control

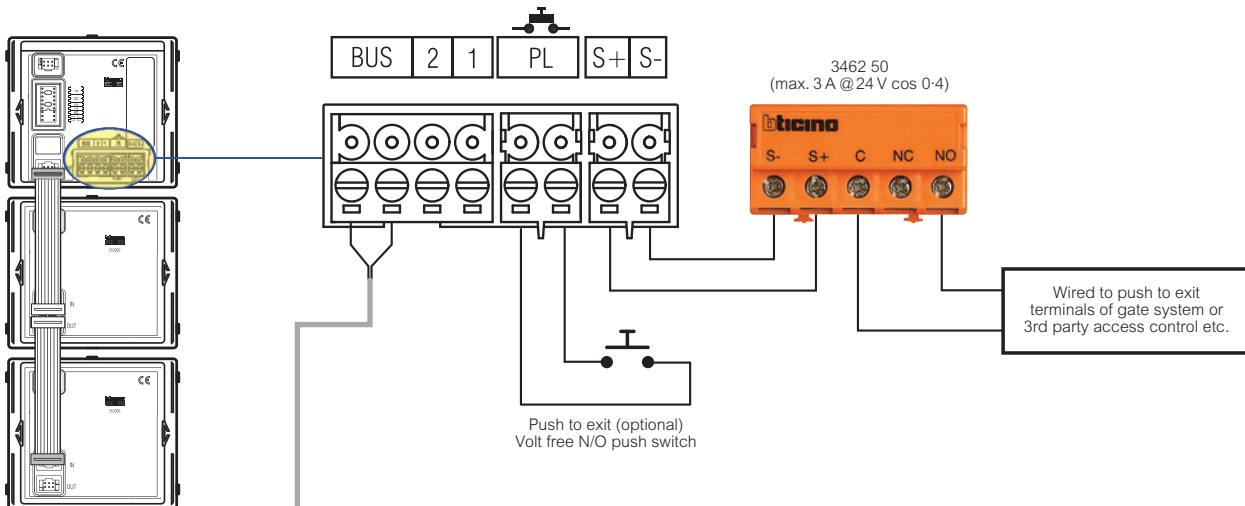

■ If you require assistance, please contact our technical support helpline on **0370 608 9020** or email **dooreentry.uk.technical@legrand.com**

## ENTRANCE PANEL MOUNTING AND CABLING GUIDELINES

### BACKBOX SIZES

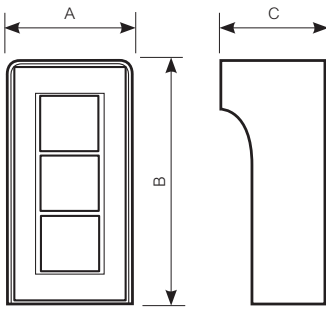

Dimensions (mm)			
Cat. Nos.	A	B	C
BT4WAKIT	151	151	82
BT4WVKIT BT6WVKIT BT6WAKIT BT8WVKIT BT8WAKIT BT10WVKIT BT10WAKIT BT12WAKIT	151	242	82
BT12WVKIT BT14WVKIT BT14WAKIT BT16WVKIT BT16WAKIT BT18WVKIT BT18WAKIT	151	334	82

■ If you require assistance, please contact our technical support helpline on **0370 608 9020** or email [doorentry.uk.technical@legrand.com](mailto:doorentry.uk.technical@legrand.com)

### RECOMMENDED MOUNTING HEIGHTS AND FIELD OF VIEW (to centre of camera)

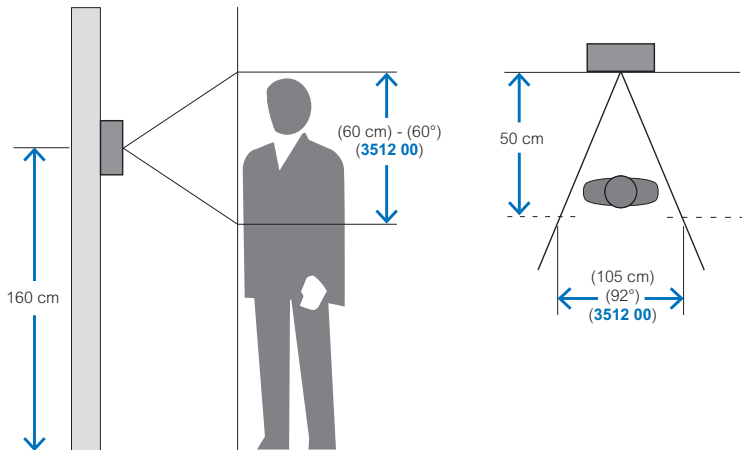

### CABLING GUIDELINES

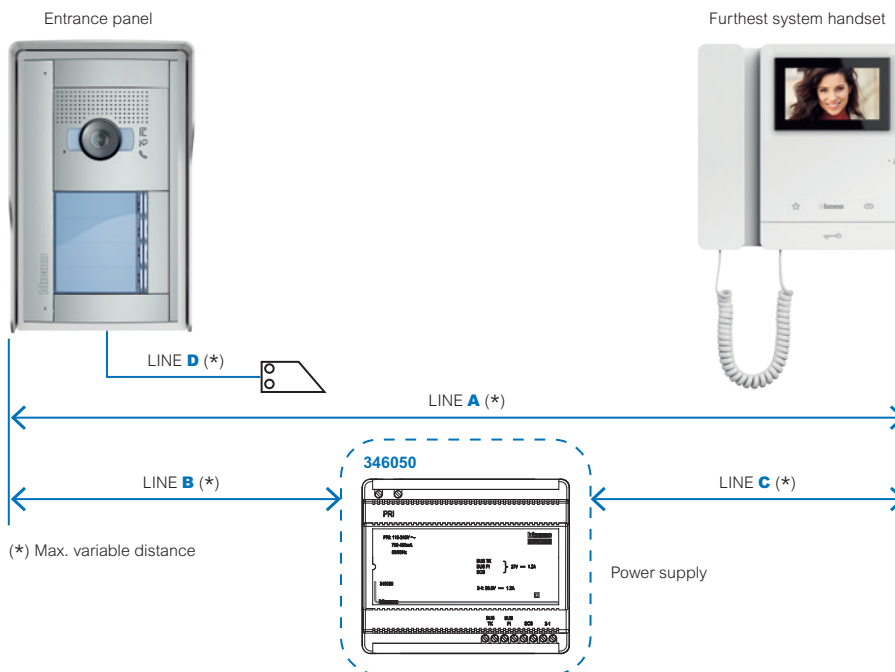

(\*) Max. variable distance

LINE max. distance	2 core untwisted 0.2 mm	Cat 5 single twisted pair	Telephone single twisted pair 0.28 mm	Bticino 3369 04/3369 05
A	50 m	125 m	125 m	200 m
B	50 m	70 m	70 m	150 m
C	50 m	75 m	75 m	170 m
D	10 m	30 m	30 m	50 m

■ Recommended cable **3369 04/3369 05** for best performance  
We cannot guarantee the performance of 3rd party cable suppliers



**OPTIONAL ADVANCED SETTINGS AND FEATURES**

FLOOR CALL (doorbell)

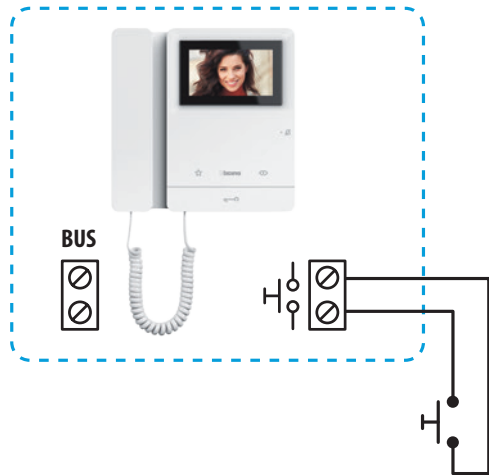

A non-illuminated bell push can be wired to the pushbutton terminals of the internal handset, this will ring the internal unit with a different audio tone to let you know that somebody is at the apartment door

This removes the need to install a separate bell transformer and chime

The maximum distance between the call to the floor push button and the internal unit is 15 m

DOOR LOCK TIMING (T configuration)

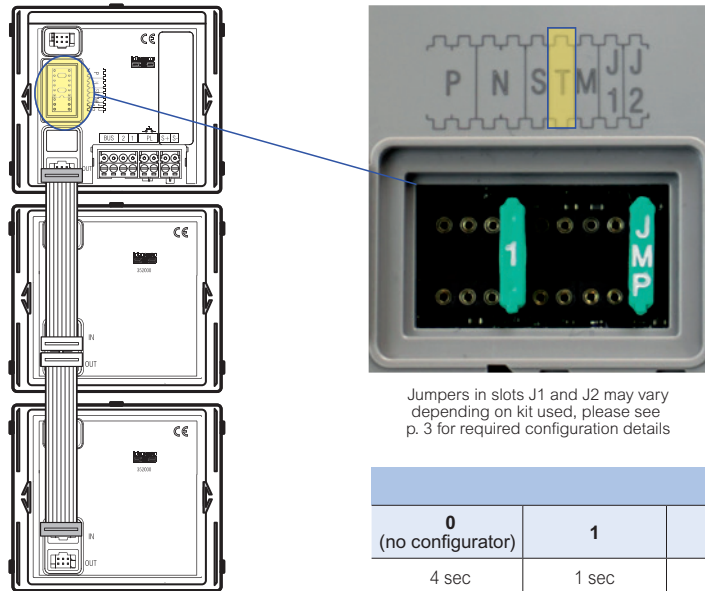

As default, the speaker module without a configurator in the "T" slot will allow the door lock to operate for 4 seconds, if a different door lock operation time is desired, you can change the door lock timing to match the table below (additional purchase of configurators may be required)

Jumpers in slots J1 and J2 may vary depending on kit used, please see p. 3 for required configuration details

Configurator Number						
0 (no configurator)	1	2	3	5	6	7
4 sec	1 sec	2 sec	3 sec	6 sec	8 sec	10 sec

For door lock times greater than 10 seconds and/or different lock requirements please contact our technical support team who would be more than happy to assist

## TROUBLESHOOTING

### System does not power up

- Check the incoming supply of the power supply is 230 V
- Check the BUS voltage on BUS terminals of all devices is 27 V DC
- Check for loose connections on the system

### System powers up but does not call correctly

- Check the BUS is 27 V DC is at every point, including entrance panel and internal handsets and make sure that the BUS is wired to the correct terminals on each device
- Check entrance panel and handset configurators are correct, please see the configuration guide on p. 3
- Reset the power to the system. The configuration must be done with the system powered off as the configuration only gets read into the system when it is powered up
- Check you are pressing the correct call button, please see the call button positions on p. 3 which shows the configuration positions of the call buttons
- Check the JMP configurator is correct in the J1 slot of the entrance panel as shown on p. 2 and 3, once this has been changed a power reset must be performed to read in the new configuration
- If the handset is not calling, check the ringer volume settings on the right-hand side of the internal unit to make sure the ringer volume is at a suitable level, see p. 3

### Door lock is not working correctly

- Check 12-18 V DC is on terminals S+ and S- of the entrance panel whilst the door lock button on the handsets is being pressed
- Check the door lock wiring is correct for the type of door lock you have, see p. 4
- Check the push to exit button (if installed) is a sprung return N/O push switch

### Video has interference

- Low voltage cabling should not be run with mains equipment, check the wiring runs are not being run along with power cables anywhere on the system
- Check end of line switches are set to the 'ON' position for every internal handset as shown on p. 3
- Make sure you are using the correct type of twisted pair cabling as recommended within the cabling guidelines shown on p. 5 (do not double up on a cat 5, use a single twisted pair i.e. brown pair)
- Check BUS TK and BUS PI connections on the power supply are wired correctly. BUS TK should feed the entrance panel and BUS PI should feed the internal units/distribution blocks

### Audio low / squealing

- If you hear squealing at the entrance panel during conversation (Larson effect) this could be due to the mic and loudspeaker adjustments both being set too high causing the A/V module to self amplify. Fine tune the mic and speaker until squealing stops and the desired audio level is achieved. These can be found on the front of the A/V module and adjusted using the orange adjustment tool supplied with the A/V module, see p. 3
- Low speech audio can be rectified with fine tune adjustment to the mic and loudspeaker. The settings for these are located on the front of the A/V module of the entrance panel and can be changed using the orange adjustment tool supplied with the A/V module, see p. 3

■ If you require assistance, please contact our technical support helpline on **0370 608 9020** or email [doorenyuk.technical@legrand.com](mailto:doorenyuk.technical@legrand.com)

## Contact details

### United Kingdom

Great King Street North,  
Birmingham, B19 2LF

### Customer Services:

Tel: +44 (0) 345 605 4333

E-mail: [legrand.sales@legrand.co.uk](mailto:legrand.sales@legrand.co.uk)

### Quotations and Technical Support:

Tel: +44 (0) 370 608 9020

E-mail: [doentry.uk.technical@legrand.com](mailto:doentry.uk.technical@legrand.com)

### Republic of Ireland:

Tel: 01 295 9673

E-mail: [legrand.sales@legrand.co.uk](mailto:legrand.sales@legrand.co.uk)



FOLLOW  
US AT

@ [www.legrand.co.uk](http://www.legrand.co.uk)  
[www.legrand.ie](http://www.legrand.ie)  
 [www.youtube.com/legrandtvuk](http://www.youtube.com/legrandtvuk)  
 [www.twitter.com/legranduk](http://www.twitter.com/legranduk)  
 [www.linkedin.com/  
company/legranduk](http://www.linkedin.com/company/legranduk)



### Head office (UK and Ireland):

Legrand Electric Limited  
Great King Street North, Birmingham, B19 2LF  
Tel: +44 (0) 370 608 9000  
Website: [www.legrand.co.uk](http://www.legrand.co.uk)